

McCall Outdoor Science School

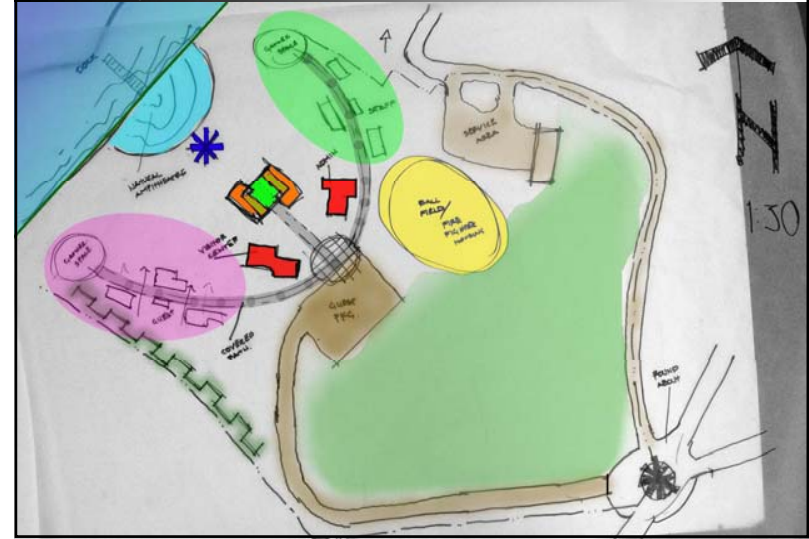

Amanda Engel

McCall Outdoor Science School Schematic Design



McCall Outdoor Science School Site Section



McCall Outdoor Science School Master Plan



McCall Outdoor Science School Cabin Perspective



McCall Outdoor Science School Floorplan & Elevations

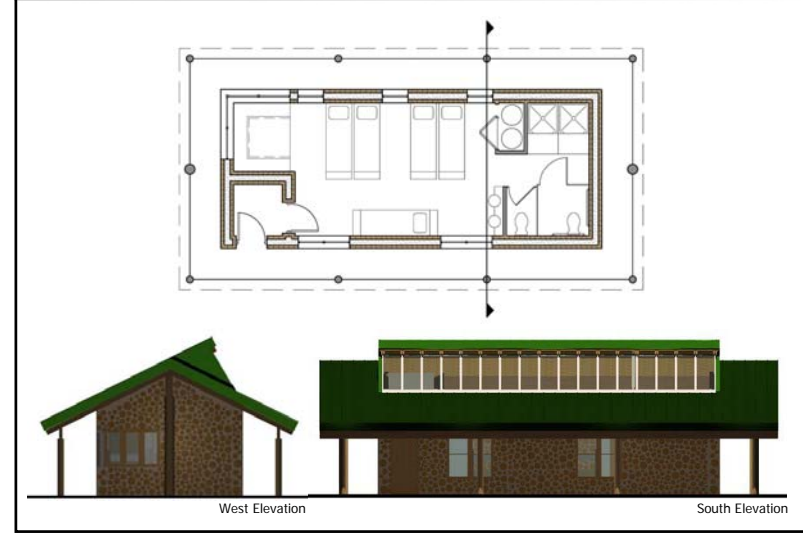

McCall Outdoor Science School Alternate Floorplans

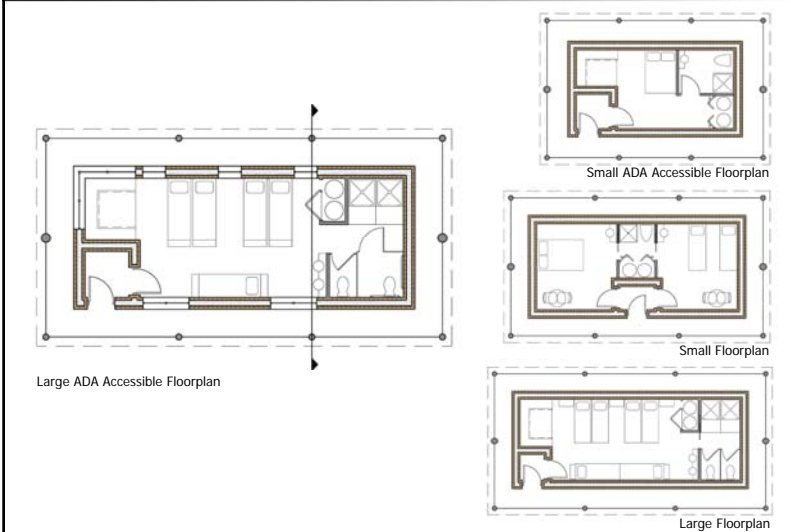

McCall Outdoor Science School Section

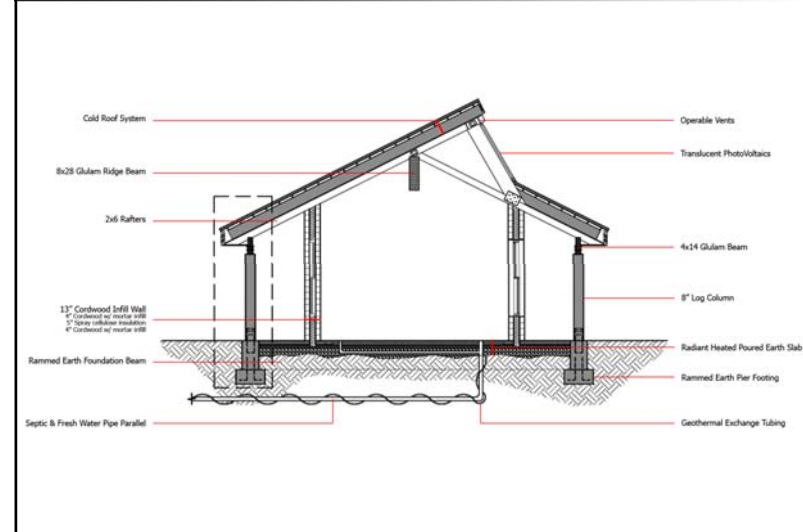

McCall Outdoor Science School
Foundation Detail

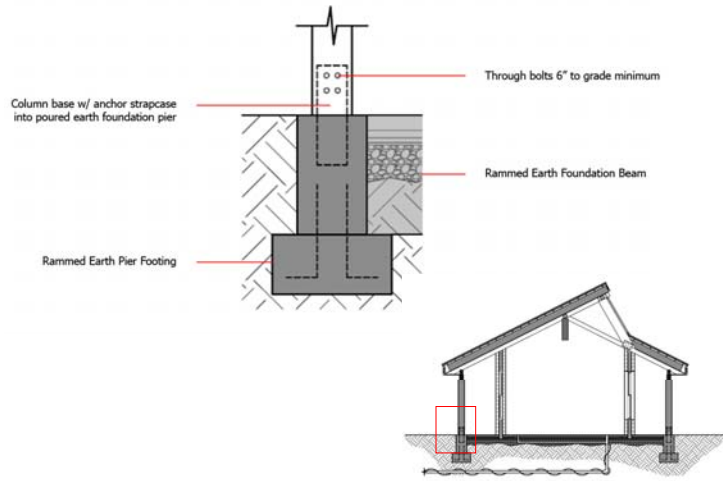

McCall Outdoor Science School
Radiant Floor Detail

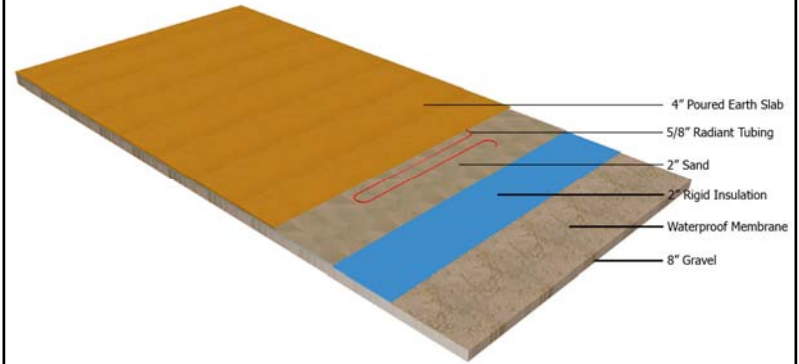

McCall Outdoor Science School
Roof Connection Detail

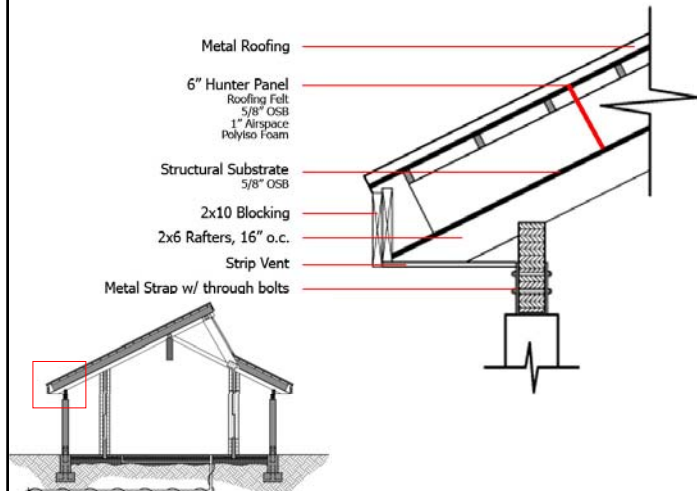

McCall Outdoor Science School
Structural Diagram



McCall Outdoor Science School
Ventilation Diagram

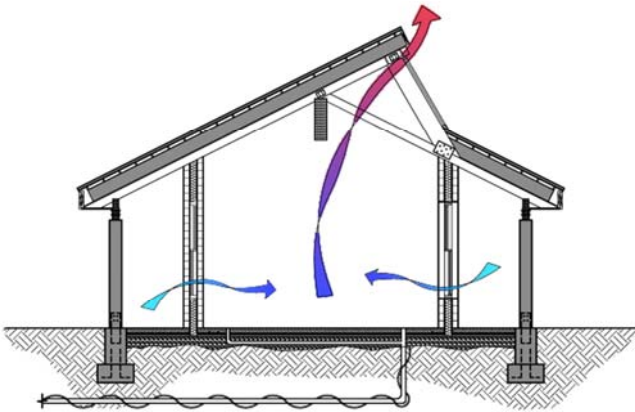

McCall Outdoor Science School
Sun Diagram

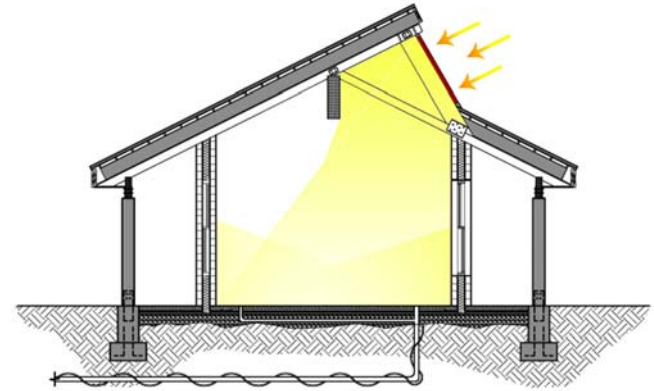

McCall Outdoor Science School
Plumbing & Geothermal Diagram

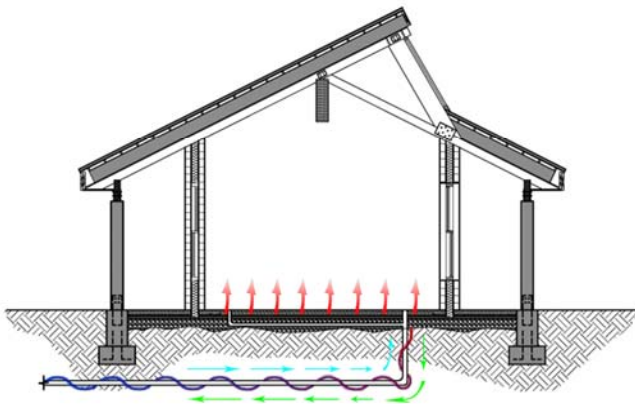

McCall Outdoor Science School
Thermal Comfort Diagrams

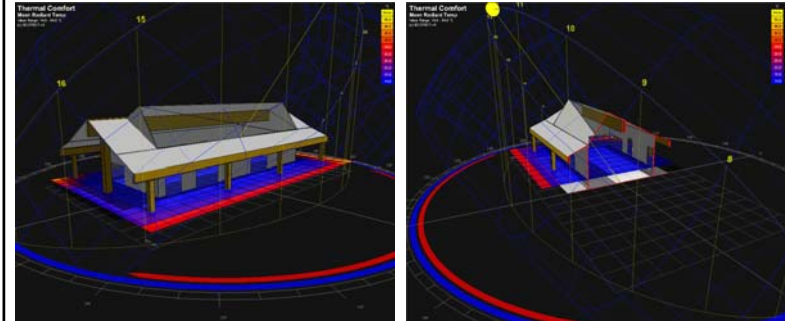

McCall Outdoor Science School

Daylighting Diagrams

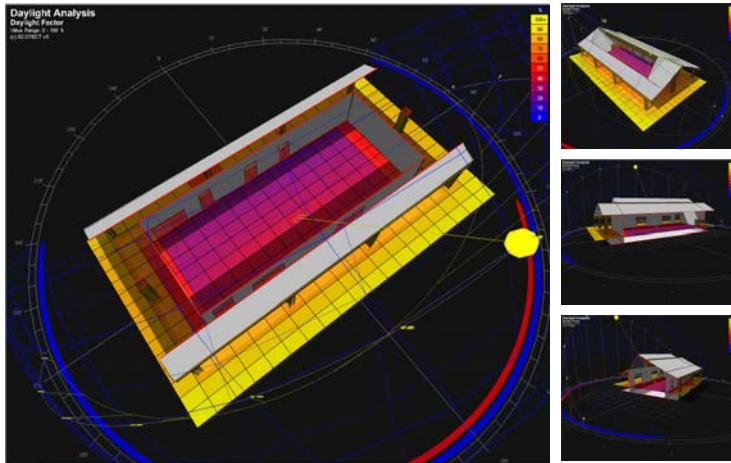

McCall Outdoor Science School

Materials & Carbon Debt

Material	Initial Cost	Lifetime Cost
Rammed Earth Pier Footings	Low	None
Rammed Earth Foundation Beam	Low	None
Poured Earth Slab on Grade	Low	None
Rigid Insulation	High	Average
Radiant Tubing	Average	Low
Log Columns-Pine	Low	Low
Glulam Beams	Average	Low
2x6 Nominal Lumber	Average	Low
5/8" OSB Sheathing	Average	Low
Hunter Panel-Cold Roof Panel	High	Average
Depth 6"		
R-28.1		
Metal Roofing	Average	Average
Cordwood Infill Walls		
R-33		
-13" stacked cordwood	Low	Low
-8" mortar	Average	Low
-5" spray cellulose insulation	Low	Low

McCall Outdoor Science School

Perspective of Cabin Pod



McCall Outdoor Science School

Interior Perspectives



McCall Outdoor Science School
Cabin Perspective

